

N-Channel Logic Level Enhancement Mode Field Effect Transistor



ON Semiconductor®

www.onsemi.com

NDS331N

General Description

These N-Channel logic level enhancement mode power field effect transistors are produced using ON Semiconductor's proprietary, high cell density, DMOS technology. This very high density process is especially tailored to minimize on-state resistance. These devices are particularly suited for low voltage applications in notebook computers, portable phones, PCMCIA cards, and other battery powered circuits where fast switching, and low in-line power loss are needed in a very small outline surface mount package.

Features

- 1.3 A, 20 V
 - ◆ $R_{DS(on)} = 0.21 \Omega @ V_{GS} = 2.7 V$
 - ◆ $R_{DS(on)} = 0.16 \Omega @ V_{GS} = 4.5 V$
- Industry Standard Outline SOT-23 Surface Mount Package Using Proprietary SUPERSOT™-3 Design for Superior Thermal and Electrical Capabilities
- High Density Cell Design for Extremely Low $R_{DS(on)}$
- Exceptional On-Resistance and Maximum DC Current Capability
- This is a Pb-Free Device

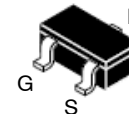

SOT-23/SUPERSOT-23, 3 LEAD, 1.4x2.9
CASE 527AG

MARKING DIAGRAM

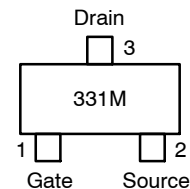

M = Date Code

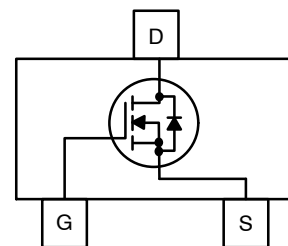

ORDERING INFORMATION

Device	Package	Shipping†
NDS331N	SOT-23-3/ SUPERSOT-23 (Pb-Free)	3000 / Tape & Reel

†For information on tape and reel specifications, including part orientation and tape sizes, please refer to our Tape and Reel Packaging Specifications Brochure, BRD8011/D.

NDS331N

ABSOLUTE MAXIMUM RATINGS $T_A = 25^\circ\text{C}$ unless otherwise noted.

Symbol	Parameter	Ratings	Unit
V_{DSS}	Drain–Source Voltage	20	V
V_{GSS}	Gate–Source Voltage – Continuous	± 8	V
I_D	Maximum Drain Current – Continuous (Note 1a)	1.3	A
	Maximum Drain Current – Pulsed	10	
P_D	Maximum Power Dissipation (Note 1a)	0.5	W
	Maximum Power Dissipation (Note 1b)	0.46	
T_J, T_{STG}	Operating and Storage Temperature Range	-55 to $+150$	$^\circ\text{C}$

Stresses exceeding those listed in the Maximum Ratings table may damage the device. If any of these limits are exceeded, device functionality should not be assumed, damage may occur and reliability may be affected.

THERMAL CHARACTERISTICS

Symbol	Parameter	Ratings	Unit
$R_{\theta JA}$	Thermal Resistance, Junction–to–Ambient (Note 1a)	250	$^\circ\text{C}/\text{W}$
$R_{\theta JC}$	Thermal Resistance, Junction–to–Case (Note 1)	75	$^\circ\text{C}/\text{W}$

1. $R_{\theta JA}$ is the sum of the junction–to–case and case–to–ambient thermal resistance where the case thermal reference is defined as the solder mounting surface of the drain pins. $R_{\theta JC}$ is guaranteed by design while $R_{\theta CA}$ is determined by the user’s board design.

$$P_D(t) = \frac{T_J - T_A}{R_{\theta JA}(t)} = \frac{T_J - T_A}{R_{\theta JC} + R_{\theta CA}(t)} = I_D^2(t) \times R_{DS(on)@T_J}$$

Typical $R_{\theta JA}$ using the board layouts shown below on 4.5”x5” FR-4 PCB in a still air environment:



- a) $250^\circ\text{C}/\text{W}$ when mounted on a 0.02 in² pad of 2oz copper.



- b) $270^\circ\text{C}/\text{W}$ when mounted on a 0.001 in² pad of 2oz copper.

Scale 1:1 on letter size paper

NDS331N

ELECTRICAL CHARACTERISTICS $T_A = 25^\circ\text{C}$ unless otherwise noted.

Symbol	Parameter	Test Conditions	Min	Typ	Max	Unit
--------	-----------	-----------------	-----	-----	-----	------

OFF CHARACTERISTICS

BV_{DSS}	Drain–Source Breakdown Voltage	$V_{GS} = 0\text{ V}, I_D = 250\ \mu\text{A}$	20	–	–	V
I_{DSS}	Zero Gate Voltage Drain Current	$V_{DS} = 16\text{ V}, V_{GS} = 0\text{ V}$	–	–	1	μA
		$V_{DS} = 16\text{ V}, V_{GS} = 0\text{ V}, T_J = 125^\circ\text{C}$	–	–	10	
I_{GSSF}	Gate–Body Leakage, Forward	$V_{GS} = 8\text{ V}, V_{DS} = 0\text{ V}$	–	–	100	nA
I_{GSSR}	Gate–Body Leakage, Reverse	$V_{GS} = -8\text{ V}, V_{DS} = 0\text{ V}$	–	–	-100	nA

ON CHARACTERISTICS (Note 2)

$V_{GS(th)}$	Gate Threshold Voltage	$V_{DS} = V_{GS}, I_D = 250\ \mu\text{A}$	0.5	0.7	1	V
		$V_{DS} = V_{GS}, I_D = 250\ \mu\text{A}, T_J = 125^\circ\text{C}$	0.3	0.53	0.8	
$R_{DS(on)}$	Static Drain–Source On–Resistance	$V_{GS} = 2.7\text{ V}, I_D = 1.3\text{ A}$	–	0.15	0.21	Ω
		$V_{GS} = 2.7\text{ V}, I_D = 1.3\text{ A}, T_J = 125^\circ\text{C}$	–	0.24	0.4	
		$V_{GS} = 4.5\text{ V}, I_D = 1.5\text{ A}$	–	0.11	0.16	
$I_{D(on)}$	On–State Drain Current	$V_{GS} = 2.7\text{ V}, V_{DS} = 5\text{ V}$	3	–	–	A
		$V_{GS} = 4.5\text{ V}, V_{DS} = 5\text{ V}$	4	–	–	
g_{FS}	Forward Transconductance	$V_{DS} = 5\text{ V}, I_D = 1.3\text{ A}$	–	3.5	–	S

DYNAMIC CHARACTERISTICS

C_{iss}	Input Capacitance	$V_{DS} = 10\text{ V}, V_{GS} = 0\text{ V}, f = 1.0\text{ MHz}$	–	162	–	pF
C_{oss}	Output Capacitance		–	85	–	pF
C_{rss}	Reverse Transfer Capacitance		–	28	–	pF

SWITCHING CHARACTERISTICS (Note 2)

$t_{D(on)}$	Turn–On Delay Time	$V_{DD} = 5\text{ V}, I_D = 1\text{ A}, V_{GS} = 5\text{ V}, R_{GEN} = 6\ \Omega$	–	5	20	ns
t_r	Turn–On Rise Time		–	25	40	ns
$t_{D(off)}$	Turn–Off Delay Time		–	10	20	ns
t_f	Turn–Off Fall Time		–	5	20	ns
Q_g	Total Gate Charge	$V_{DS} = 5\text{ V}, I_D = 1.3\text{ A}, V_{GS} = 4.5\text{ V}$	–	3.5	5	nC
Q_{gs}	Gate–Source Charge		–	0.3	–	nC
Q_{gd}	Gate–Drain Charge		–	1	–	nC

DRAIN–SOURCE DIODE CHARACTERISTICS AND MAXIMUM RATINGS

I_S	Maximum Continuous Drain–Source Diode Forward Current	–	–	0.42	A	
I_{SM}	Maximum Pulsed Drain–Source Diode Forward Current	–	–	10	A	
V_{SD}	Drain–Source Diode Forward Voltage	$V_{GS} = 0\text{ V}, I_S = 0.42\text{ A}$ (Note 2)	–	0.8	1.2	V

Product parametric performance is indicated in the Electrical Characteristics for the listed test conditions, unless otherwise noted. Product performance may not be indicated by the Electrical Characteristics if operated under different conditions.

2. Pulse Test: Pulse Width $\leq 300\ \mu\text{s}$, Duty Cycle $\leq 2.0\%$.

TYPICAL ELECTRICAL CHARACTERISTICS

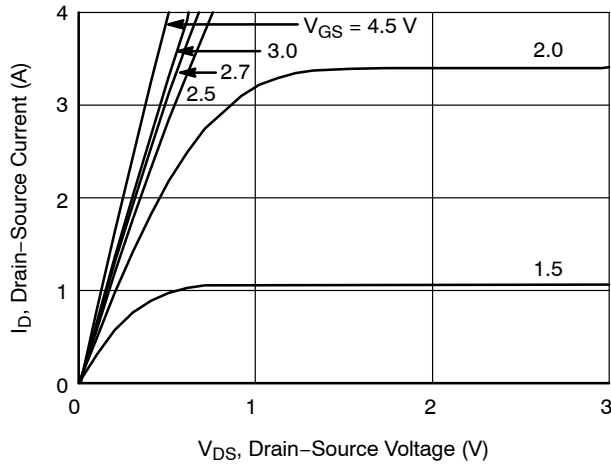

Figure 1. On-Region Characteristics

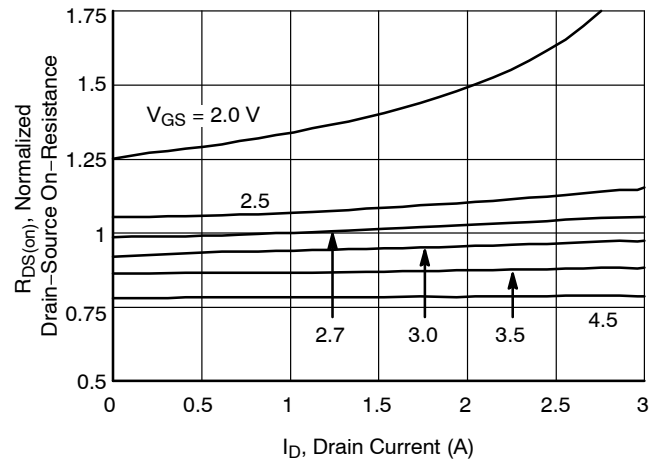

Figure 2. On-Resistance Variation with Drain Current and Gate Voltage

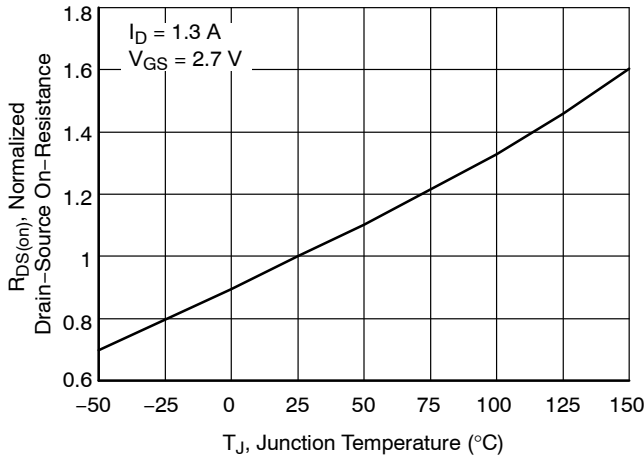

Figure 3. On-Resistance Variation with Temperature

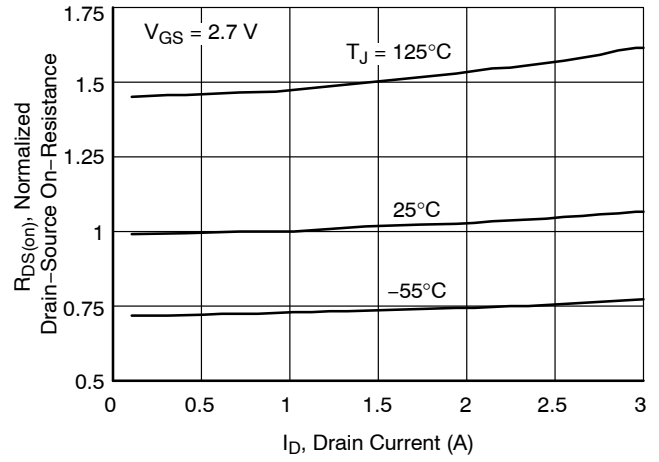

Figure 4. On-Resistance Variation with Drain Current and Temperature

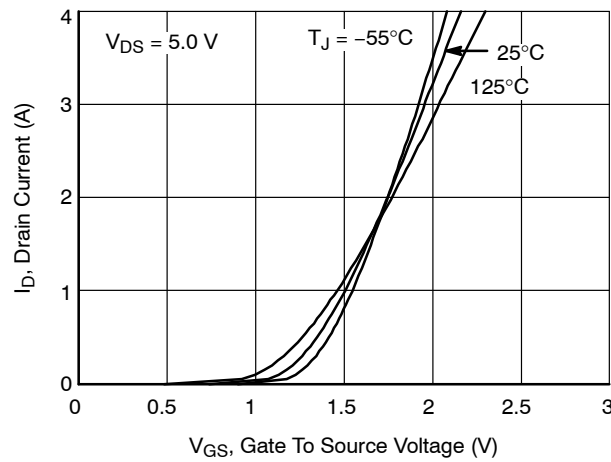

Figure 5. Transfer Characteristics

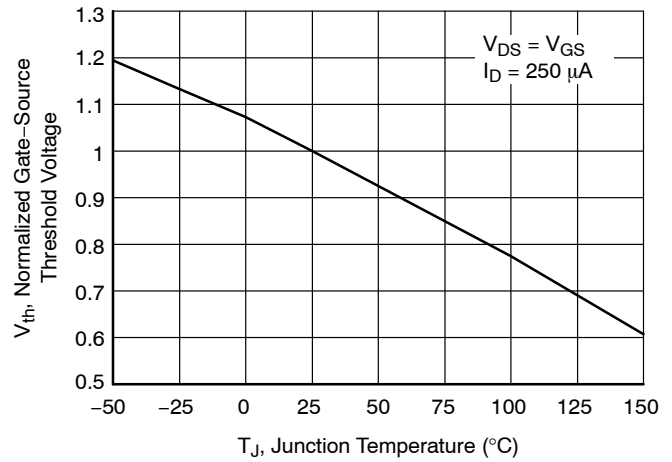

Figure 6. Gate Threshold Variation with Temperature

TYPICAL ELECTRICAL CHARACTERISTICS (continued)

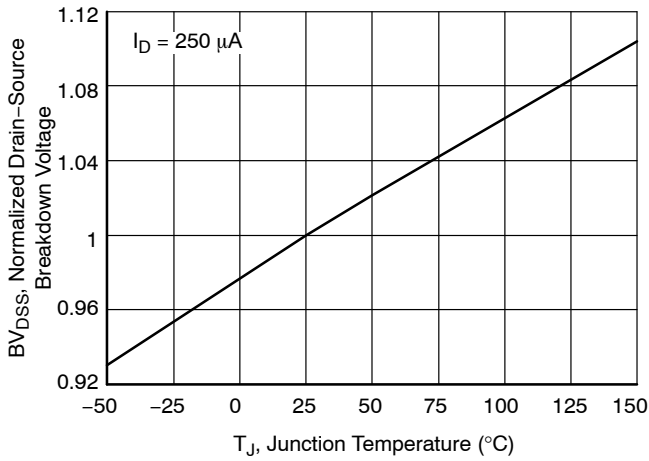

Figure 7. Breakdown Voltage Variation with Temperature

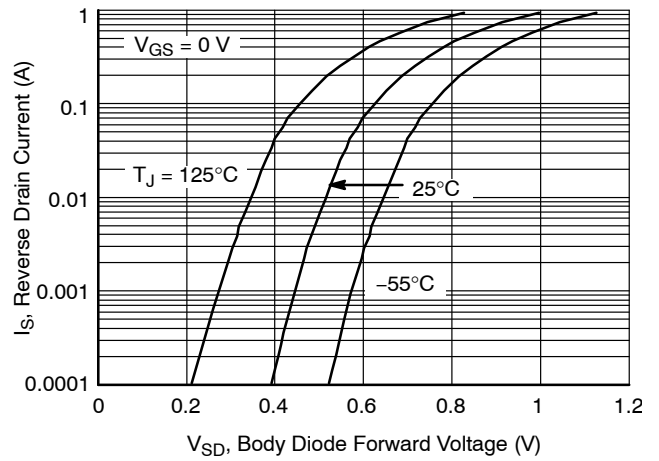

Figure 8. Body Diode Forward Voltage Variation with Source Current and Temperature

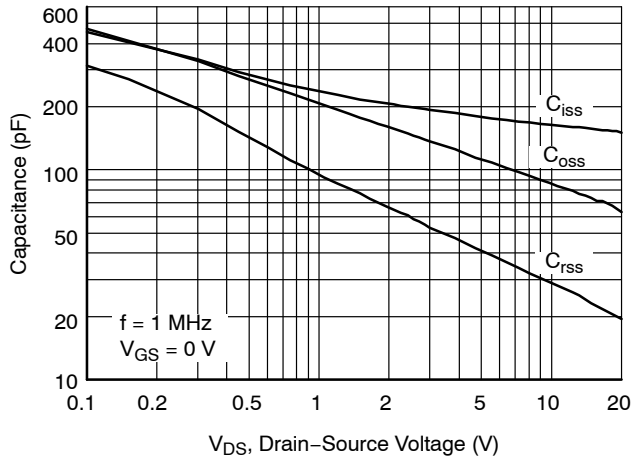

Figure 9. Capacitance Characteristics

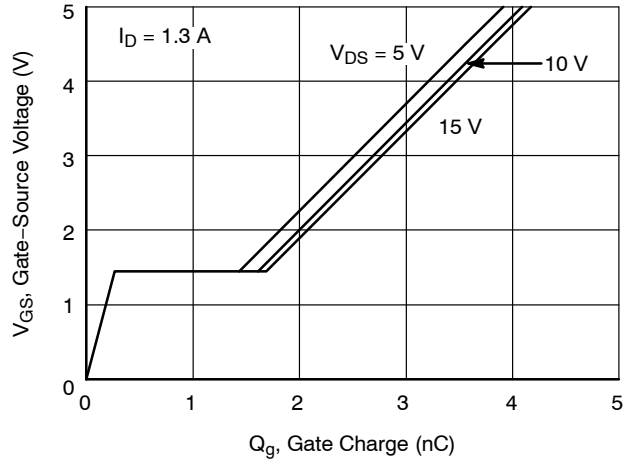

Figure 10. Gate Charge Characteristics

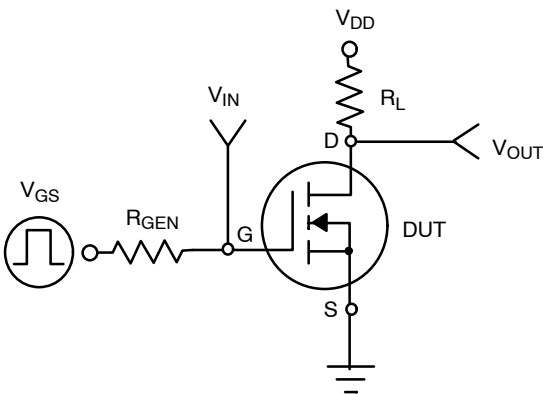

Figure 11. Switching Test Circuit

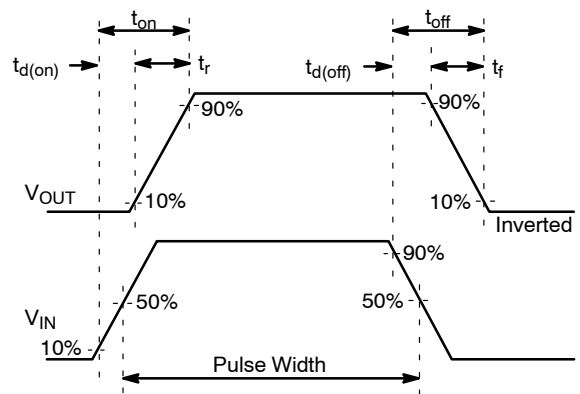

Figure 12. Switching Waveforms

TYPICAL ELECTRICAL CHARACTERISTICS (continued)

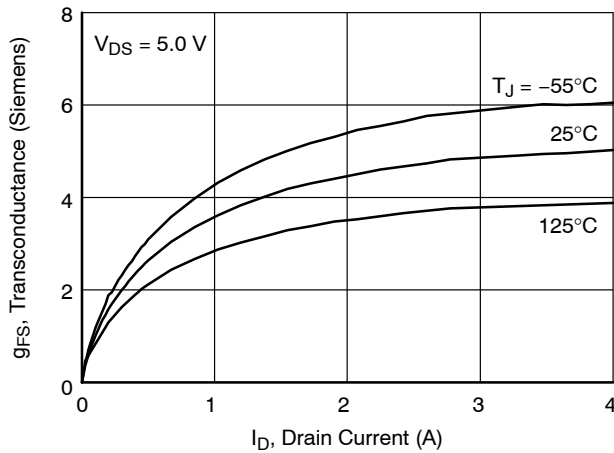

Figure 13. Transconductance Variation with Drain Current and Temperature

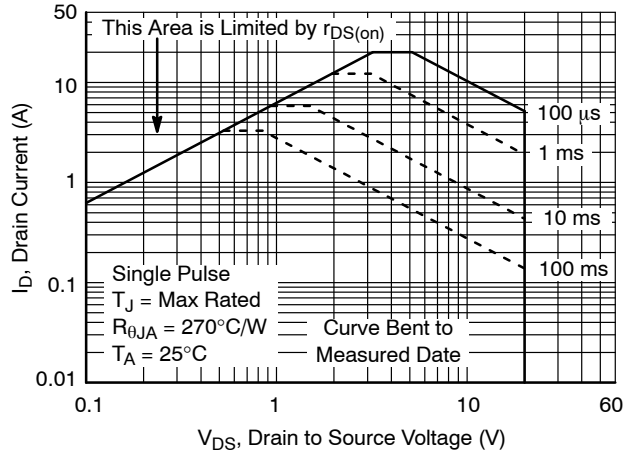

Figure 14. Maximum Safe Operating Area

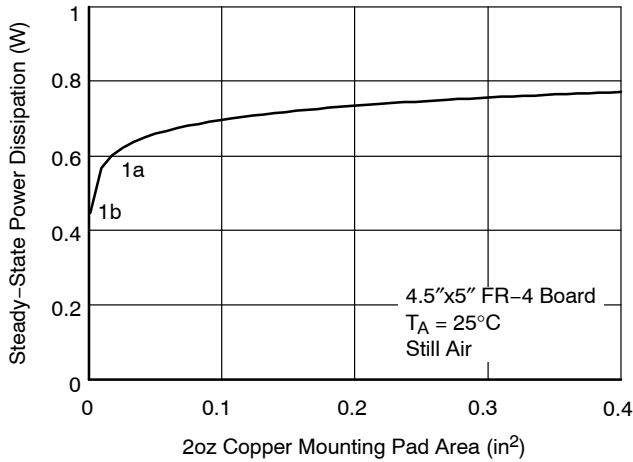

Figure 15. SUPERSOT-3 Maximum Steady-State Power Dissipation versus Copper Mounting Pad Area

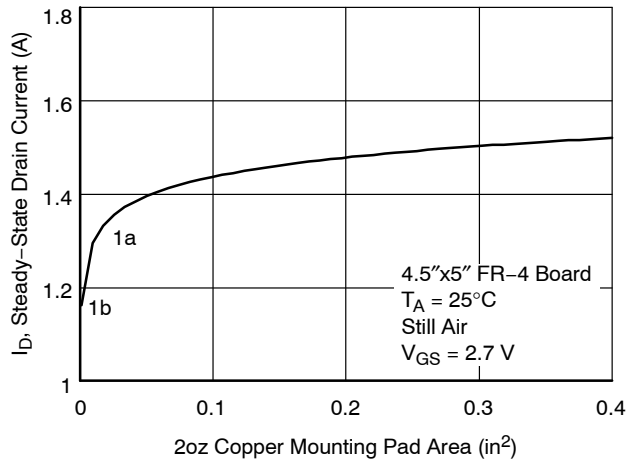

Figure 16. Maximum Steady-State Drain Current versus Copper Mounting Pad Area

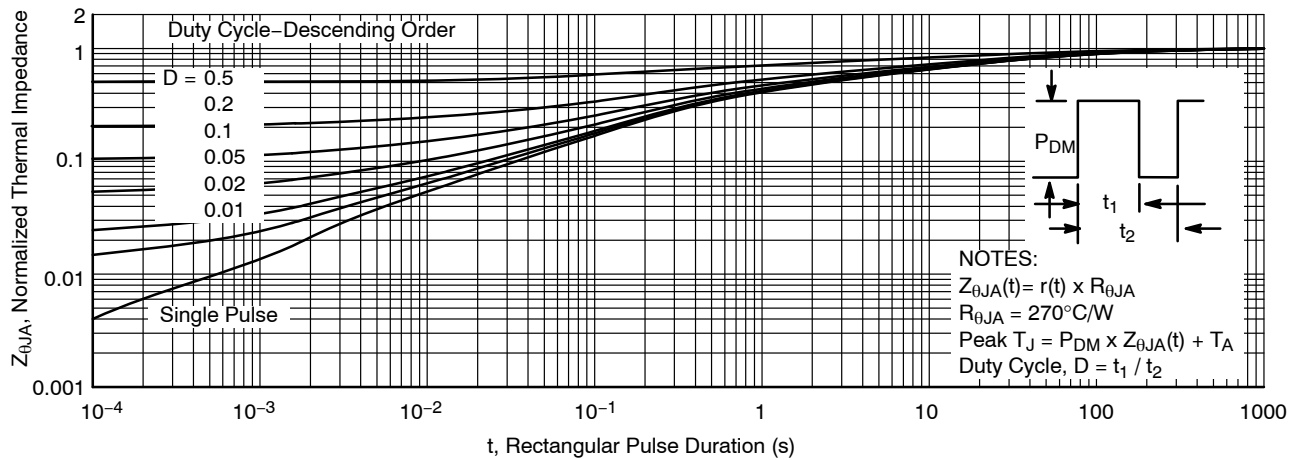

Figure 17. Transient Thermal Response Curve

NOTE: Thermal characterization performed using the conditions described in Note 1b. Response will change depending on the circuit board design.

NDS331N

SUPERSOT is a trademark of Semiconductor Components Industries, LLC (SCILLC) or its subsidiaries in the United States and/or other countries.

MECHANICAL CASE OUTLINE

PACKAGE DIMENSIONS

ON Semiconductor®



SOT-23/SUPERSOT™ -23, 3 LEAD, 1.4x2.9

CASE 527AG
ISSUE A

DATE 09 DEC 2019

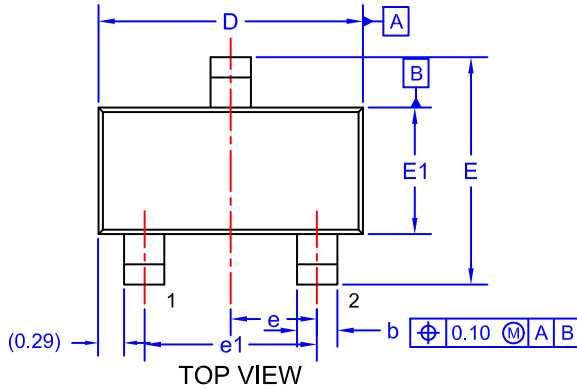

NOTES: UNLESS OTHERWISE SPECIFIED

1. DIMENSIONING AND TOLERANCING PER ASME Y14.5M, 2009.
2. ALL DIMENSIONS ARE IN MILLIMETERS.
3. DIMENSIONS ARE EXCLUSIVE OF BURRS, MOLD FLASH AND TIE BAR EXTRUSIONS.

DIM	MIN.	NOM.	MAX.
A	0.85	0.95	1.12
A1	0.00	0.05	0.10
b	0.370	0.435	0.508
c	0.085	0.150	0.180
D	2.80	2.92	3.04
E	2.31	2.51	2.71
E1	1.20	1.40	1.52
e	0.95 BSC		
e1	1.90 BSC		
L	0.33	0.38	0.43

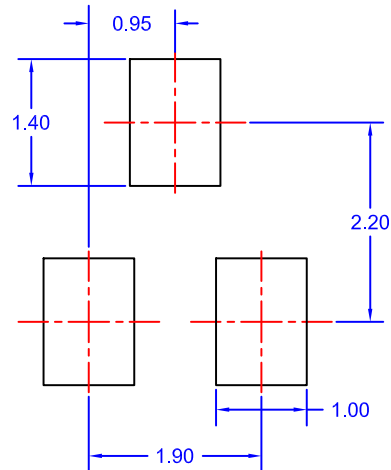
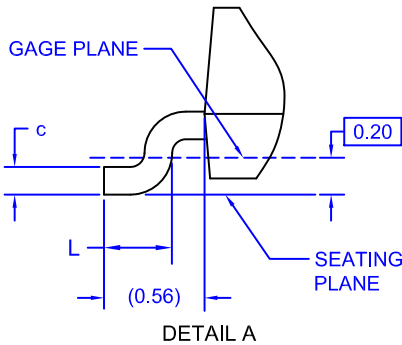
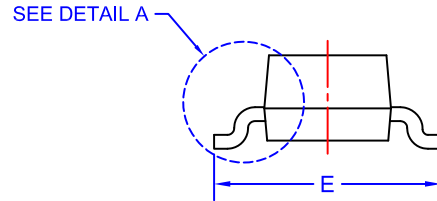
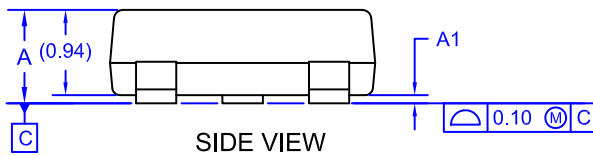

*FOR ADDITIONAL INFORMATION ON OUR Pb-FREE STRATEGY AND SOLDERING DETAILS, PLEASE DOWNLOAD THE ON SEMICONDUCTOR SOLDERING AND MOUNTING TECHNIQUES REFERENCE MANUAL, SOLDERRM/D.

GENERIC MARKING DIAGRAM*

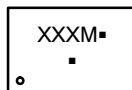

- XXX = Specific Device Code
- M = Month Code
- = Pb-Free Package

(Note: Microdot may be in either location)

*This information is generic. Please refer to device data sheet for actual part marking. Pb-Free indicator, "G" or microdot "▪", may or may not be present. Some products may not follow the Generic Marking.

DOCUMENT NUMBER:	98AON34319E	Electronic versions are uncontrolled except when accessed directly from the Document Repository. Printed versions are uncontrolled except when stamped "CONTROLLED COPY" in red.
DESCRIPTION:	SOT-23/SUPERSOT-23, 3 LEAD, 1.4X2.9	PAGE 1 OF 1

ON Semiconductor and are trademarks of Semiconductor Components Industries, LLC dba ON Semiconductor or its subsidiaries in the United States and/or other countries. ON Semiconductor reserves the right to make changes without further notice to any products herein. ON Semiconductor makes no warranty, representation or guarantee regarding the suitability of its products for any particular purpose, nor does ON Semiconductor assume any liability arising out of the application or use of any product or circuit, and specifically disclaims any and all liability, including without limitation special, consequential or incidental damages. ON Semiconductor does not convey any license under its patent rights nor the rights of others.

onsemi, **Onsemi**, and other names, marks, and brands are registered and/or common law trademarks of Semiconductor Components Industries, LLC dba "**onsemi**" or its affiliates and/or subsidiaries in the United States and/or other countries. **onsemi** owns the rights to a number of patents, trademarks, copyrights, trade secrets, and other intellectual property. A listing of **onsemi**'s product/patent coverage may be accessed at www.onsemi.com/site/pdf/Patent-Marking.pdf. **onsemi** reserves the right to make changes at any time to any products or information herein, without notice. The information herein is provided "as-is" and **onsemi** makes no warranty, representation or guarantee regarding the accuracy of the information, product features, availability, functionality, or suitability of its products for any particular purpose, nor does **onsemi** assume any liability arising out of the application or use of any product or circuit, and specifically disclaims any and all liability, including without limitation special, consequential or incidental damages. Buyer is responsible for its products and applications using **onsemi** products, including compliance with all laws, regulations and safety requirements or standards, regardless of any support or applications information provided by **onsemi**. "Typical" parameters which may be provided in **onsemi** data sheets and/or specifications can and do vary in different applications and actual performance may vary over time. All operating parameters, including "Typicals" must be validated for each customer application by customer's technical experts. **onsemi** does not convey any license under any of its intellectual property rights nor the rights of others. **onsemi** products are not designed, intended, or authorized for use as a critical component in life support systems or any FDA Class 3 medical devices or medical devices with a same or similar classification in a foreign jurisdiction or any devices intended for implantation in the human body. Should Buyer purchase or use **onsemi** products for any such unintended or unauthorized application, Buyer shall indemnify and hold **onsemi** and its officers, employees, subsidiaries, affiliates, and distributors harmless against all claims, costs, damages, and expenses, and reasonable attorney fees arising out of, directly or indirectly, any claim of personal injury or death associated with such unintended or unauthorized use, even if such claim alleges that **onsemi** was negligent regarding the design or manufacture of the part. **onsemi** is an Equal Opportunity/Affirmative Action Employer. This literature is subject to all applicable copyright laws and is not for resale in any manner.

PUBLICATION ORDERING INFORMATION

LITERATURE FULFILLMENT:

Email Requests to: orderlit@onsemi.com

onsemi Website: www.onsemi.com

TECHNICAL SUPPORT

North American Technical Support:

Voice Mail: 1 800-282-9855 Toll Free USA/Canada

Phone: 011 421 33 790 2910

Europe, Middle East and Africa Technical Support:

Phone: 00421 33 790 2910

For additional information, please contact your local Sales Representative